

RPower OGiV12170LP (12V 17Ah AGM Battery)

Floating Life at 20°C designed for 10-12 years

EAN: 4260349823326

Dimensions

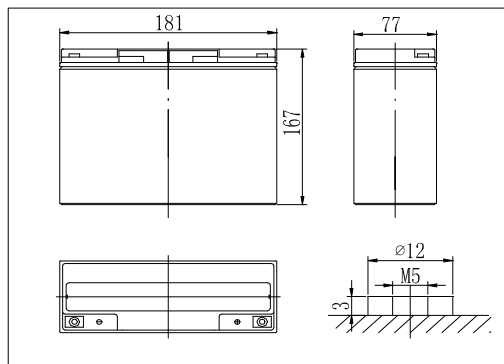

Specifications

Nominal Voltage		12V
Capacity (20hr@25°C@1.75V/C)		17Ah
Dimensions	Length	181mm (7.13inch)
	Width	77mm (3.03inch)
	Height	167mm (6.57inch)
	Total Height	167mm (6.57inch)
Approx. Weight		5.50kg (12.13lbs)
Maximum charging current		5.10A
Maximum discharge current		170A (5sec.)
Internal resistance		Approx. 16mΩ
Capacity affected by temperature (20hr)	40°C	103%
	25°C	100%
	0°C	86%
	-15°C	65%
Self-discharge (25°C)	3 month	Remaining Capacity: 91%
	6 month	Remaining Capacity: 82%
	12 month	Remaining Capacity: 65%
Nominal operating temperature		25°C ±3°C (77°F±5°F)
Operating temperature range		-20°C~55°C (-4°F~131°F)
Float charging voltage (25°C)		13.65 to 13.80V
Cyclic charging voltage (25°C)		14.40 to 15.00V
Terminal material		Copper

The Relationship for Charging Voltage and Temperature

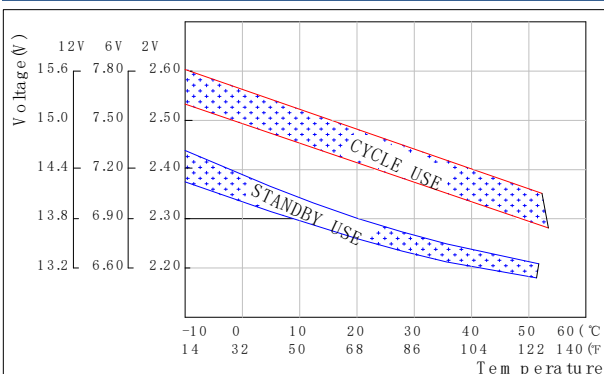

Charging Characteristics (25°C)

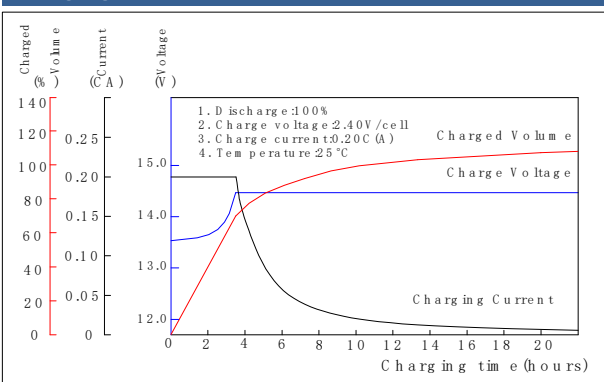

Discharge Characteristics (25°C)

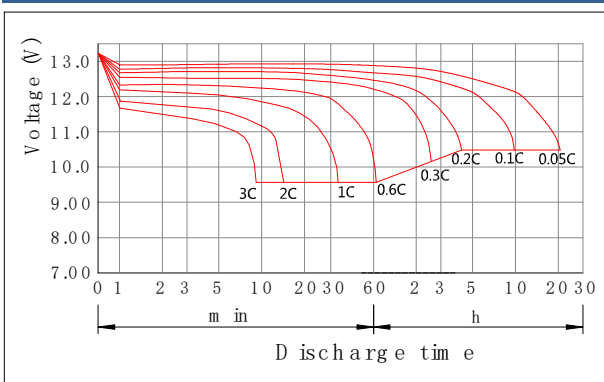

Constant Current Discharge Characteristics (Ampere / Battery, 25°C)

FV / TIME	5min	10min	15min	20min	30min	45min	1h	2h	3h	4h	5h	6h	8h	10h	20h
10.98V	55,68	39,58	31,43	24,25	17,65	12,90	10,86	5,47	4,15	3,27	2,84	2,42	1,93	1,60	0,81
10.80V	57,40	40,80	32,40	25,00	18,20	13,30	11,20	5,64	4,28	3,37	2,93	2,49	1,99	1,65	0,84
10.50V	60,10	41,90	33,30	25,70	18,70	13,50	11,40	5,78	4,36	3,47	3,01	2,55	2,02	1,68	0,85
10.20V	62,60	43,10	34,20	26,30	19,10	13,60	11,60	5,94	4,43	3,56	3,07	2,58	2,05	1,72	0,89
9.90V	64,90	44,20	35,10	27,00	19,60	13,80	11,80	6,15	4,51	3,65	3,13	2,63	2,07	1,75	0,90
9.60V	67,00	45,30	36,00	27,70	20,00	13,90	12,00	6,34	4,58	3,76	3,19	2,67	2,10	1,78	0,91

Constant Power Discharge Characteristics (Watt / Battery, 25°C)

FV / TIME	5min	10min	15min	20min	30min	45min	1h	2h	3h	4h	5h	6h	8h	10h	20h
10.98V	663,48	453,38	364,91	279,36	210,10	162,96	130,95	72,75	50,87	38,64	34,45	28,58	22,81	18,92	9,60
10.80V	684,00	467,40	376,20	288,00	216,60	168,00	135,00	75,00	52,44	39,84	35,52	29,46	23,52	19,50	9,90
10.50V	708,00	475,80	383,40	295,80	220,20	170,40	136,20	76,20	52,98	41,04	35,64	30,12	23,88	19,86	10,02
10.20V	738,00	484,80	390,00	303,00	223,20	172,20	138,00	76,80	53,52	42,07	36,06	30,48	24,24	20,34	10,50
9.90V	762,00	493,20	397,20	310,80	226,80	174,60	139,20	78,00	54,06	43,15	36,54	31,08	24,48	20,70	10,62
9.60V	786,00	501,60	403,80	319,20	229,80	176,40	140,40	78,60	54,60	44,46	36,96	31,56	24,82	21,04	10,76